

GX 12/35

THE COMPACT STACKER



This compact, powerful and robust stacker is the ideal solution for working in confined spaces. The reduced width (800 mm), the lateral driving system and the wide mast positioning allow great manoeuvrability, stability and visibility. Built-in battery charger with integrated cable and plug make it a plug and play unit!

GX

The STANDARD version is equipped with starting type battery, a tiller made with metal tube and ergonomic controls. This configuration is the best value for money choice.

MANOEUVRABILITY

The overall width is the same as the Europallet (800 mm) to allow working in narrow spaces and corridors, increasing manoeuvrability and reducing the turning radius. The combination of side guide, wide mast and low cover offer outstanding visibility.

TILLER

Fully integrated ergonomic tiller system including finger tip throttle and fork controls, safety pushbutton, horn and turtle button.

GX12



COVER

Strong ABS cover with storage compartments on top, easily removable to speed up maintenance operations. The bottom access opening enables an immediate disassembly of motor wheel, portal and tiller without lifting the machine. Schuko plug with spiral cable for an easy battery charging.



BATTERY PACK BASIC

The separate battery compartment is the housing of starting batteries. Such batteries are lightweight and inexpensive and are ideal for discontinuous use.



Description

1.1 Manufacturer			PR INDUSTRIAL
1.3 Drive			Electric
1.4 Operator type			Pedestrian
1.5 Load capacity	Q	kg	1200
1.6 Load centre distance	c	mm	600
1.8 Load axle to end forks	x	mm	780
1.9 Wheel base	y	mm	1234

Weights

2.1 Service weight (battery included)		kg	578
2.2 Axle load, laden rear		kg	1187
2.2 Axle load, laden front		kg	591
2.3 Axle load, unladen front		kg	416
2.3 Axle load, unladen rear		kg	162

Tyres/Chassis

3.1 Tyres: front wheels			RUBBER
3.1 Tyres: stabilizers wheels - front			POLY.C.
3.1 Tyres: rear wheels			POLY.C.
3.2 Tyre size: Steering wheels - Width		mm	76
3.2 Tyre size: Steering wheels - Diameter		mm	250
3.3 Tyre size: Load rollers - Diameter		mm	82
3.3 Tyre size: Load rollers - Width		mm	70
3.4 Tyre size: stabilizers wheels front - Diameter		mm	100
3.4 Tyre size: stabilizers wheels front - Width		mm	38
3.5 Tyre size: rear wheels - Q.ty (X=driven)		nr	2
3.5 Tyre size: front wheels - Q.ty (X=driven)		nr	1x+1
3.6 Tread, front	b10	mm	565
3.7 Tread, rear	b11	mm	410

Dimensions

4.2 Height, mast lowered	h1	mm	2250
4.3 Normal free lifting	h2	mm	80
4.4 Lift height	h3	mm	3410
4.5 Height, mast extended	h4	mm	3916
4.9 Height of tiller in drive position max	h14	mm	1310
4.9 Height of tiller in drive position min	h14	mm	915
4.15 Height, lowered	h13	mm	90
4.19 Overall length	l1	mm	1760
4.20 Length to face of forks	l2	mm	610
4.21 Overall width	b1	mm	800
4.22 Fork dimensions - Thickness	s	mm	70
4.22 Fork dimensions - Width	e	mm	150
4.22 Fork dimensions - Length	l	mm	1150
4.24 Fork carriage width	b3	mm	650
4.25 Distance between fork arms	b5	mm	560
4.32 Ground clearance, centre of wheelbase	m2	mm	20
4.34 Aisle width	Ast	mm	2210
4.35 Turning radius	Wa	mm	1430

Performance data

5.1 Travel speed laden	Km/h	4.7
5.1 Travel speed unladen	Km/h	5.2
5.2 Lifting speed laden	m/s	0.11
5.2 Lifting speed unladen	m/s	0.19
5.3 Lowering speed laden	m/s	0.12
5.3 Lowering speed unladen	m/s	0.15
5.8 Max gradeability laden	%	5
5.8 Max gradeability unladen	%	10
5.10 Service brake		Electric

Electric motors

6.1 Drive motor power	kW	0.7
6.2 Lift motor power	kW	2.2
Battery Type	Type	AUTOMOTIVE
6.4 Battery voltage	V	24
6.4 Battery capacity, Min	Ah	85
6.4 Battery capacity, Max	Ah	85
6.5 Battery weight, Min	kg	34
6.5 Battery weight, Max	kg	100
6.6 Energy consumption according to VDI cycle	kWh/h	0.9
8.4 Sound level at driver's ear	dB(A)	62

Residual lifting capacity

Lifting height (H3) 2500 mm	Kg	1200
Lifting height (H3) 2900 mm	Kg	800
Lifting height (H3) 3500 mm	Kg	600

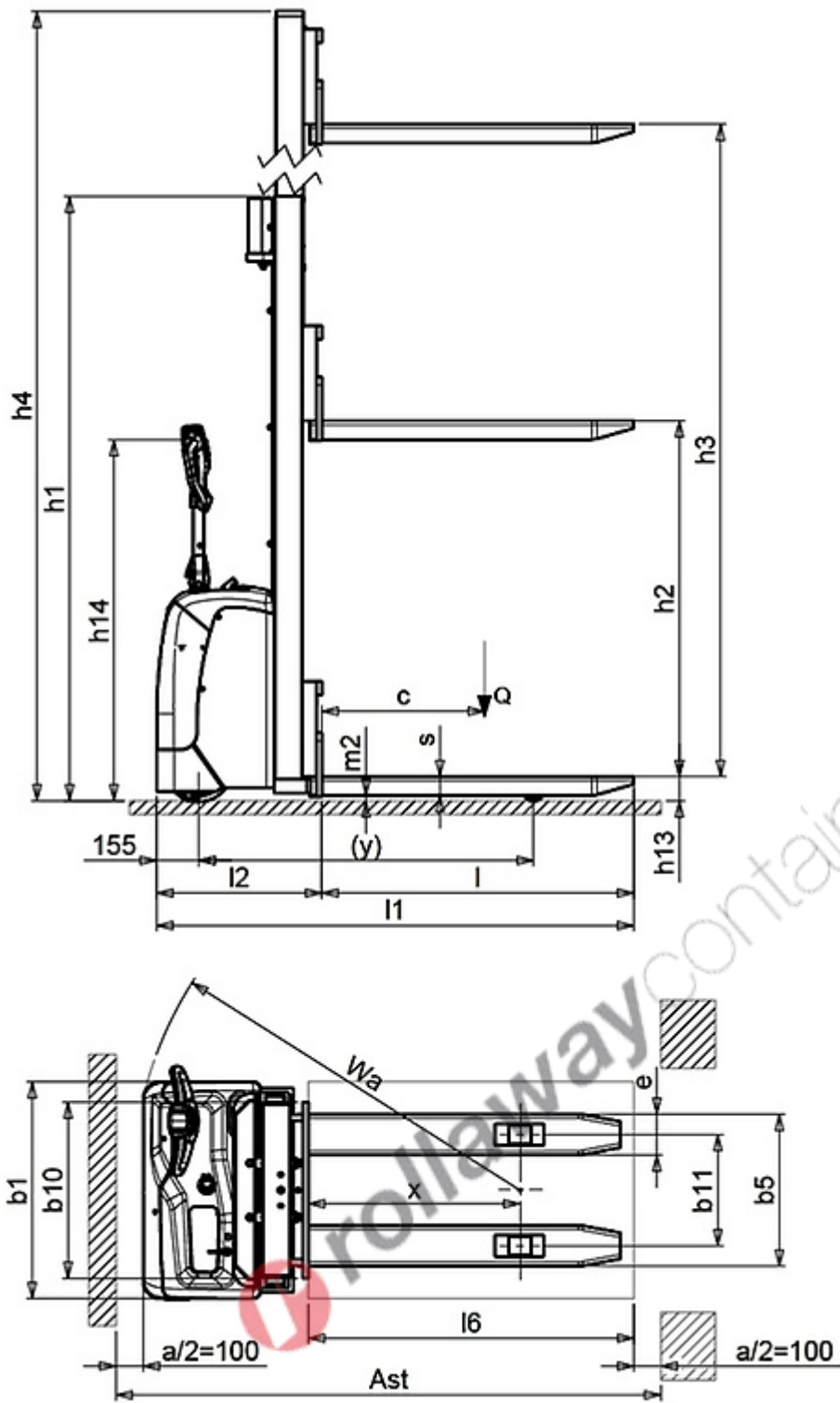

The information is aligned with the Data file at the time of download. Printed on 21/02/2022 (ID 4277)

©2022 | PR INDUSTRIAL s.r.l. | All rights reserved | Image shown may not reflect actual package. Specifications subject to change without notice

