

UTENSILI BETA IN TERMOFORMATO MORBIDO 5904VG/3M ASSORTIMENTO DI 130 UTENSILI
BETA TOOLS IN SOFT THERMOFORMED TRAY 5904VG/3M WITH 130 TOOLS



M15 M16 M153



M50 M55 M292



M208 M85 M234







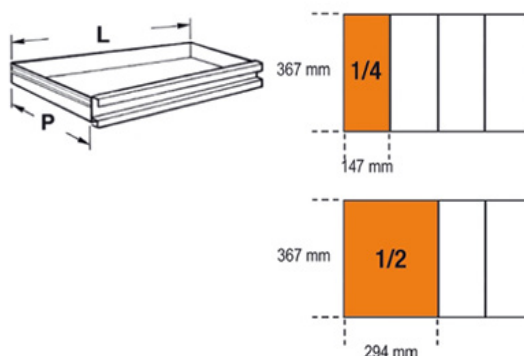







M83 M134 M145

CODICE CODE	B059041220
TERMOFORMATO THERMOFORMED	Morbido Soft
PESO (KG) WEIGHT (KG)	16,2













COMPONENTI
COMPONENTS

ARTICOLO ITEM	CODICE BETA BETA CODE	DESCRIZIONE DESCRIPTION	PEZZI PIECES
	42	Chiavi combinate 6÷21 mm Combination wrenches 6÷21 mm Chiavi combinate 22 - 24 - 27 - 30 - 32 mm Combination wrenches 22 - 24 - 27 - 30 - 32 mm	16 5
	1048	Pinze regolabili cerniera chiusa 250 mm Slip joint pliers boxed joints 250 mm	1
	1052	Pinza autobloccante 240 mm Self - locking pliers 240 mm	1
	96T	Chiavi maschio esagonale con impugnatura Offset hexagon key wrenches 2-2,5-3-4-5-6-7-8 mm	8
	97TTX	Chiavi maschio con impugnatura per viti con impronta Torx® Drivers for Torx® head screws, with handles T10-T15-T20-T25-T30	5

ARTICOLO ITEM	CODICE BETA BETA CODE	DESCRIZIONE DESCRIPTION	PEZZI PIECES
	111	Chiave regolabile a rullino 250 mm <i>Adjustable wrench 250 mm</i>	1
	1128BMX	Forbici per elettricisti lame diritte <i>Electrician's scissors, straight blades</i>	1
	1692/5	Flessometro 5 m <i>Measuring tape 5 m</i>	1
	1771	Cutter con lama a settori 170 mm <i>Snap - off blade utility knife 170 mm</i>	1
	1260	Giravite lama piatta <i>Screwdrivers for slotted head screws</i> 3x75 - 3,5x100 - 4x125 - 5,5x150 - 6,5x150 mm	5
	1262	Giravite per viti con impronta a croce Phillips® <i>Screwdrivers for cross head Phillips® screws</i> PH0x60 - PH1x80 - PH2x100 mm	3
	1260N	Giravite nano lama piatta 4x30 mm <i>Screwdrivers for slotted head screws, extra-short series - 4x30 mm</i>	1
	1262N	Giraviti nano Phillips®, PH1x30 mm <i>Screwdrivers for cross head Phillips® screws, extra - short series , PH1x30 mm</i>	1
	860LP	Inseri colorati per avvitatori per viti a testa con intaglio <i>Bits for slotted head screws, coloured</i> 0,5x3 - 0,6x4,5 - 0,8x5,5 - 1x5,5 - 1,2x6,5 mm	5
	860PE	Inseri colorati maschio esagonale per avvitatori <i>Hexagon bits for power drivers, coloured</i> 2 - 2,5 - 3 - 4 - 5 - 6 - 8 - 10 mm	8
	860PH	Inseri colorati per avvitatori per viti con impronta a croce Phillips® <i>Bits for cross head Phillips® screws, coloured</i>	5
	860PZ	Inseri colorati per avvitatori per viti con impronta a croce Pozidriv® - Supadriv® <i>Bits for cross head Pozidriv® - Supadriv® screws, coloured</i>	4

ARTICOLO ITEM	CODICE BETA BETA CODE	DESCRIZIONE DESCRIPTION	PEZZI PIECES
	860TX	Inserti colorati per avvitatori per viti con impronta Torx® <i>Bits for Torx® head screws, coloured</i> T6-T7-T8-T9-T10-T15-T20-T25-T27-T30-T40	11
	860RTX	Inserti colorati per avvitatori per viti con impronta Tamper Resistant Torx® <i>Bits for Tamper Resistant Torx® head screws, coloured</i> T9-T10-T15-T20-T25-T27-T30-T40	8
	851SR	Portainseri a sgancio rapido con impugnatura 230 mm <i>Magnetic bit holder with handle 230 mm</i>	1
	860/55	Cricchetto reversibile portainseri 100 mm <i>Reversible bit ratchet 100 mm</i>	1
	882P	Prolunga portainseri magnetica 80 mm <i>Magnetic bit holder extension bar 80 mm</i>	1
	892	Raccordi per avvitatori 1/4 - 1/4 <i>Adaptors for drivers 1/4 - 1/4</i>	1
	35	Scalpelli piatti nervati 100 - 200 mm <i>Flat chisels, ribbed type 100 - 200 mm</i>	2
	1370	Martello tipo tedesco 300 g <i>Engineer's hammer 300 g</i>	1
	1390	Mazzuola con battenti in materiale plastico Ø 35 mm <i>Soft face hammer Ø 35 mm</i>	1
	920AN	Prolunga angolare - 1/2" 125 mm Prolunga angolare - 1/2" 250 mm <i>1/2" wobble extension bar 125 mm</i> <i>1/2" wobble extension bar 250 mm</i>	2
	920/25	Snodo 1/2" <i>1/2" drive universal joint</i>	1

ARTICOLO ITEM	CODICE BETA BETA CODE	DESCRIZIONE DESCRIPTION	PEZZI PIECES
	920/42	Quadro maschio 1/2" con spina scorrevole <i>1/2" drive sliding T-handle</i>	1
	920/55	Cricchetto reversibile 1/2" <i>1/2" drive reversible ratchet</i>	1
	920A	Chiavi a bussola esagonali 1/2" <i>1/2" square drive hexagon sockets</i> 10÷24 - 26 - 27 - 30 - 32 Mm	19
	1082GBM	Tronchesi a taglienti diagonali, finitura industriale 160 mm <i>Diagonal cutting nippers, bi-material handles, industrial finish 160 mm</i>	1
	1150GBM	Pinze universali a grande effetto, finitura industriale 180 mm <i>Heavy duty combination pliers, bi-material handles, industrial finish 180 mm</i>	1
	1166GBM	Pinze a becchi mezzotondi lunghissimi, diritti zigrinati, impugnatura bimateriale, finitura industriale - 160 mm <i>Extra-long needle knurled nose pliers, bi-material handles, industrial finish - 160 mm</i>	1
	1032	Pinze becchi diritti per anelli elastici, per fori 180 mm <i>Circlip pliers straight, internal 180 mm</i>	1
	1034	Pinze becchi piegati per anelli elastici, per fori 170 mm <i>Circlip pliers bent, internal 170 mm</i>	1
	1036	Pinze becchi diritti per anelli elastici, per alberi 175 mm <i>Circlip pliers straight, external 175 mm</i>	1
	1038	Pinze becchi piegati per anelli elastici, per alberi 175 mm <i>Circlip pliers bent, external 175 mm</i>	1